

Sondes



User Guide

This user guide covers the more commonly used range of Radiodetection Sondes. They are used to locate non metallic drain and duct structures.

Specifications are provided together with battery requirements and suitable attachment accessories for connection to most versions of push rod.

Finally the guide gives some useful tips on locating the sondes.

Sondes for Tracing Drains, Ducts and other Applications

Transmitting sondes enable receivers to trace non metallic sewers, drains, ducts or pipes and to locate blockages or collapses.

A range of special sondes and sonde elements are available for fitting to No-Dig boring tools, CCTV Inspection Cameras and are listed seperately.

Sondes are not classified as 'Intrinsically safe' for use in situations where hazardous gases are present.

Most of the Locators in RD400/RD4000 range will locate most of the sondes listed although there are exceptions so check for the relevent modes on the locator.

If the equipment is used in a manner not specified by the manufacturer, the protection provided by the equipment may be impaired.

Standard Sonde

The Standard Sonde combines compact size with a strong signal. The standard for most applications unless a smaller size, greater depth or specially rugged construction is required.

Location depth: 5m (16ft)
Weight: 190g (7oz)
Signal: continuous
Battery/Life: 1 x AA alkaline (LR6) 20 hours
Pressure: 2 bar, 20m Water
Order codes: 8kHz - 10/SC0412-8
 33kHz - 10/SC0412-33R

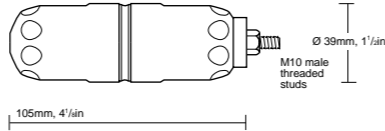

Super Small Sonde

A small Sonde with a strong signal for use small diameter pipes and ducts. An optional extended battery housing is available for No-Dig applications.

Location depth: 4m (13ft)
Weight: 73g (2.6oz)
Signal: continuous
Battery/Life: 2 x CR1/3N or D1/3N 8 hours or 2 x AA alkaline (LR6) 60 hours.
Pressure: 2 bar, 20m Water
Order codes: 33kHz - 10/S18/82-33-000
 Extended - 10/S18/173-33-000
 Plain end cap - 10/RE0958N4

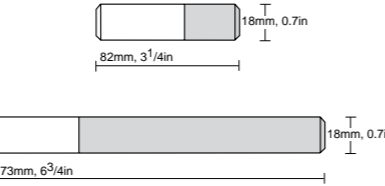

Sewer Sonde

Very strong enclosure suitable for the most abrasive and rugged duty in municipal sewer systems. The sonde has a long life for daily use in all conditions.

Location depth: 8m (16ft) minimum 0.5m (1.5ft)
Weight: 500g (1lb)
Signal: continuous or pulsed
 Reversing battery polarity changes signal
Battery/Life: 1 x 9v alkaline (6LR61) 15 hours
Pressure: 0.2 bar, 2m Water
Order codes: 33kHz - 10/SA0337-33R

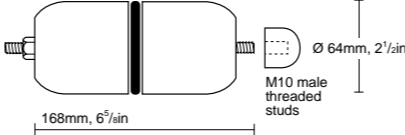

Super Sonde

Strong construction designed for use in deep sewers.

Location depth: 15m (50ft) minimum 3m (10ft)
Weight: 900g (1.75lb)
Signal: continuous or pulsed reverse battery changes signal
Battery/Life: 1 x 9v alkaline (6LR61) 5 hours
Pressure: 0.2 bar, 2m Water
Order codes: 33kHz - 10/SB0338-33R

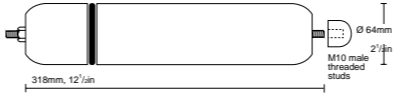

Slim Sonde

Mainly used for locating duct structures as its length prevents its use in structures with bends. Sometimes used behind small ground piercing moles.

Location depth: 3.5m (12ft)
Weight: 220g (8oz)
Signal: continuous
Battery/Life: 1 x AA alkaline (LR6) 12 hours
Pressure: 2 bar, 20m Water
Order codes: 33kHz - 10/SD0322-33R
 Plain end cap - 10/SD0223
 Blank end cap - 10/SD0268

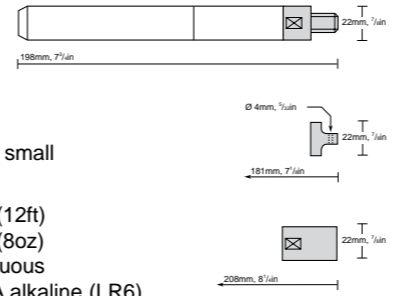

Sondes for use with the CAT and CAT+

Mega Mouse and Mega Mouse+

Combines compact size with a strong signal. The standard for most applications unless a smaller size, greater depth or specially rugged construction is required.

Location depth: 5m (16ft)
Weight: 190g (7oz)
Signal: 33kHz continuous
Battery/Life: 1 x AA alkaline (LR6) 20 hours
Pressure: 2 bar, 20m Water
Order codes: 512Hz 10/SC0412-S12
 33kHz - 10/SC0412-33R Mega Mouse+

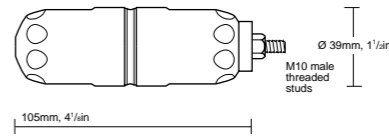

Mighty Mouse

Mainly used for locating duct structures as its length prevents its use in structures with bends. Sometimes used behind small ground piercing moles.

Location depth: 3.5m (12ft)
Weight: 220g (8oz)
Signal: continuous
Battery/Life: 1 x AA alkaline (LR6) 12 hours
Pressure: 2 bar, 20m Water
Order codes: 33kHz - 10/SD0322-33R (Mighty Mouse+)
 Plain end cap - 10/SD0223
 Blank end cap - 10/SD0268

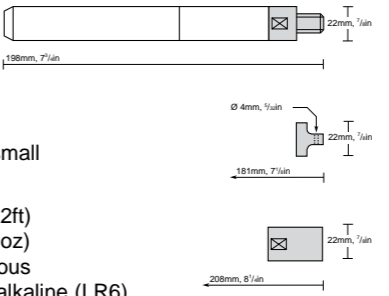

Sonde connectors and couplings



Spring coupling M10 male to match connectors
 The spring coupling should be used for attaching sondes to the FlexRod or to drain rods.
 10/SU0335



Plastic or cane rod connector
 Male thread.
 10/SU0339

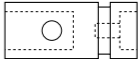

GD connector
 3/4" x 10 BSF female.
 10/SU0340



Wards 8mm connector
 3/4" x 10 BSF female.
 10/SU03401

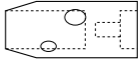

Wards 6mm connector
 1/2" x 10 BSF female.
 10/SU0342

Lockfast
 3/4" x 10 BSW.
 10/SU0676



Blank connector
 For matching by customer.
 10/SU0343

Sonde Coupling
 M10F - M12F
 02/SU1421N1

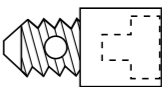

Telecom dust rod No. 1 and 2
 Connector has 0.717" dia, 7 TPI Whit. male thread and hole to match latching mechanism.
 10/SU0401



Telecom dust rod No. 5
 Connector has 7/16 BSW male thread and hole to match latching mechanism.
 10/SU0403

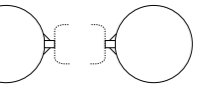

Pair of floats
 Sewer and Super Sonde only.
 10/SU0334

Note
 It is preferable to fit a spring coupling between the end of a rod and the sonde to reduce the shock to the sonde when hitting the walls of the drain or pipe and to ease the sonde around corners. It is particularly useful for starting the sonde round the sharp change of direction at the bottom of a deep chamber.

Flexrods

The Radiodetection Flexrod is used for pushing sondes into and along Sewers, Ducts and Drains up to 300m (975ft)

It is a Glass Fibre rod in a polypropylene sleeve that is resistant to abrasion, most solvents, oils and acids. The rod has a minimum bend radius of 250mm (10in) and at each end a brass collar 62mm(2.44in) in length with a female M10x20mm thread suitable for attaching all Radiodetection sondes.

The rod is wound onto a steel spool and attached to the spool using one of the brass end collars and a spring coupling. The spool has a manual brake to help the user maintain control of the rod.

The Flexrod can be used in place of Drain Rods for some applications. It can be fed into and withdrawn from the drain more quickly than Drain rods but cannot be rotted. An adaptor is available to fit the M10 end of the Flexrod, it has a blank end ready for machining or tapping to fit an appropriate drain tool.

Flexrod order codes and accessories:

Rods

Description	Rod mm	Length m	Frame mm	Part Number
FlexRod F30	9	30	600	10/FLEXRODF30
FlexRod F30-60	9	60	600	10/FLEXRODF30-60
FlexRod F60	9	60	800	10/FLEXRODF60
FlexRod F120	9	120	800	10/FLEXRODF120
FlexRod F150-9	9	150	800	10/FLEXRODF150-9
FlexRod F150-11	11	150	1000	10/FLEXRODF150-11

Accessories

Blank Adaptor:	10/FR0336
Pulling eye with 3.5mm (0.4in) diameter hole:	02/FR0824
Coupler for joining two rods:	2/FR0818NI

Radiodetection Ltd.

Western Drive, Bristol BS14 0AF, UK
 Tel: +44 (0) 117 976 7776 Fax: +44 (0) 117 976 7775
 Email: rd.sales.uk@spx.com

Radiodetection

154 Portland Road, Bridgton, ME 04009, USA
 Tel: +1 (207) 647 9495 Toll Free: +1 (877) 247 3797
 Fax: +1 (207) 647 9496 Email: rd.sales.us@spx.com

www.radiodetection.com

Radiodetection products are under continuous development and are subject to change, we reserve the right to alter or amend any published specification without notice.

Copyright 2008 Radiodetection Ltd. - SPX Corporation. All rights reserved. Radiodetection Ltd. is a subsidiary of SPX Corporation.



Flexitrace

The Flexitrace is 50m in length and similar in construction to a Flexrod, but the smaller 6.0mm (1/4in) diameter rod has wire conductors running its full length and a transmitting coil at the end.

The rod and coil can be energised by a Radiodetection transmitter to enable its location to a maximum depth of 3.0m.

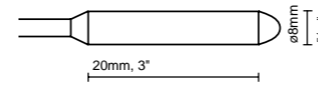
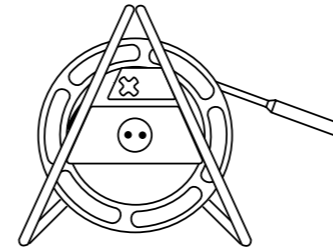

By connecting the transmitter to both stud terminals, only the transmitting head can be located, like a sonde.

By connecting the transmitter to one stud terminal and Ground the entire length of the rod can be located, like a cable.

The Flexitrace is used when size is restrictive, as it can be inserted into pipes as small as 12mm(0.5in) with a minimum bend radius of 250mm(10in).

Order codes: 10/TRACE50

Locating a Sonde

A new battery or a freshly recharged battery should be used at the beginning of each day and preferably at the start of a job. Check that the Sonde and Receiver are operating at the same frequency and working correctly.

As a quick test for both Sonde and receiver - Position the Sonde at a distance equal to its rated Depth range from the receiver. Point the receiver at the Sonde with its blade in line with the Sonde and check that the meter reads more than 50% at high sensitivity.

Note

The blade of the receiver must be in line with the Sonde, the opposite to Line locate.

With the Sonde attached to the rod insert it into the Drain or Duct to be located, but keep the just Sonde in view. Hold the receiver vertical directly over the Sonde with the blade in line with the Sonde.

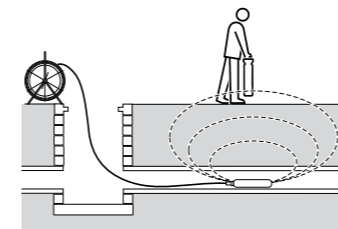

Adjust the sensitivity of the receiver to give a meter reading between 60% and 80%.

A Sonde radiates a peak field from the centre of its axis with ghost signals at each side of the peak. Move the receiver a little way to one side and then along the axis of the Sonde forwards and backwards to detect the ghost signals.

It is a good idea to locate the ghost's as finding them positively confirms the position of the main peak. To loose the ghosts reduce the sensitivity of the receiver a little leaving only the main peak detectable.

With the receiver sensitivity set as desired, propel the Sonde along three to four paces and stop. Place the receiver over the supposed position of the Sonde and...

(a) move the receiver backwards and forwards with the blade in line with the Sonde and stop when the meter indicates a clear peak.

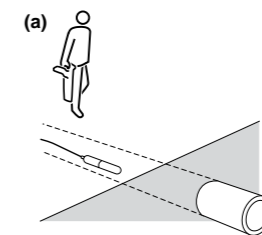

(b) rotate the receiver as if the blade were a pivot, stop when the meter indicates a clear peak.

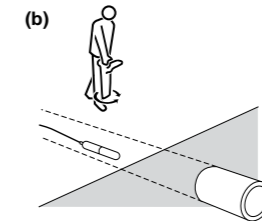

(c) move the receiver from side to side until the meter indicates a clear peak.

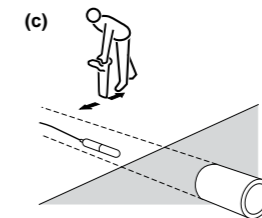

Repeat (a), (b) and (c) in smaller increments with the receiver blade resting on or near the ground. The receiver should now be directly above the Sonde with the blade in line with the Sonde, mark the position.

Propel the Sonde a further three to four paces along the drain or duct and pinpoint and mark. Repeat this procedure along the route at similar intervals. It should only be necessary to change the receiver sensitivity while tracing the Sonde if the depth of the drain or duct, or the distance between receiver and Sonde changes.

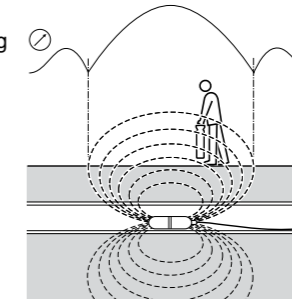

Measuring Depth to a Sonde

Pinpoint the Sonde as previously described and rest the receiver on the ground and in line with the Sonde. Adjust the sensitivity to give a meter reading of 60% to 80%.

If the receiver has a moving coil meter, ensure the needle is in the red band or on the set line then press and hold the depth key until a reading is displayed and read off from the Sonde scale.

If the receiver has a Liquid Crystal Display, check receiver is in Sonde mode, press the Depth key. The LCD will indicate 'dEP' then give a Depth reading for a few seconds.

Remember the Depth reading is from the bottom of the receiver blade to the centre of the Sonde and not to the drain or duct being located.

CAUTION: Ensure Depth readings are taken at the main peak readings taken at the ghost signal positions will be incorrect.

If the Sonde is too deep for the receiver to display or calculate depth but there is still enough signal to locate the Sonde and its ghost signals, there is a method of calculating the depth.

Pinpoint the Sonde. Move the receiver in front of the Sonde still in line with it, increasing the sensitivity slightly to find the ghost signal. Between the main peak and the ghost there is a Null or minimum, mark this position. Now move behind the Sonde and repeat, find the Null between the ghost and main peak. See Points 'A' and 'B' on the diagram. The higher the sensitivity of the receiver the sharper the Null's appear.

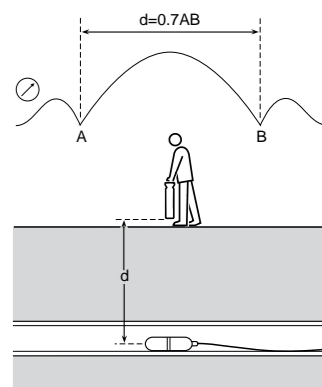

Measure the distance between points 'A' and 'B' and multiply by 0.7 to give an approximate depth measurement.